



marantz®

AV Surround Receiver
SR7013

Quick Start Guide

Kurzanleitung / Guide de démarrage rapide / Guida di Avvio Rapido /
Guía de inicio rápido / Snelhandleiding / Snabbstartsguide /
Краткое руководство пользователя / Skrócona instrukcja obsługi

Read Me First....

Bitte zuerst lesen... / Lisez-moi en premier.... / Nota preliminare.... /
Lea esto primero.... / Lees mij eerst... / Läs detta först... /
Прочитайте в первую очередь... / Przeczytaj to najpierw....

ENGLISH

DEUTSCH

FRANÇAIS

ITALIANO

ESPAÑOL

NEDERLANDS

SVENSKA

РУССКИЙ

POLSKI

Welcome

Thank you for choosing a Marantz AV receiver.

This guide provides step-by-step instructions for setting up your AV receiver.

Please do not return this unit to the store – call for assistance.

If you need help... :

If you need additional help in solving problems, contact Marantz customer service in your area.

www.marantz.com

Before You Begin

Required for Setup

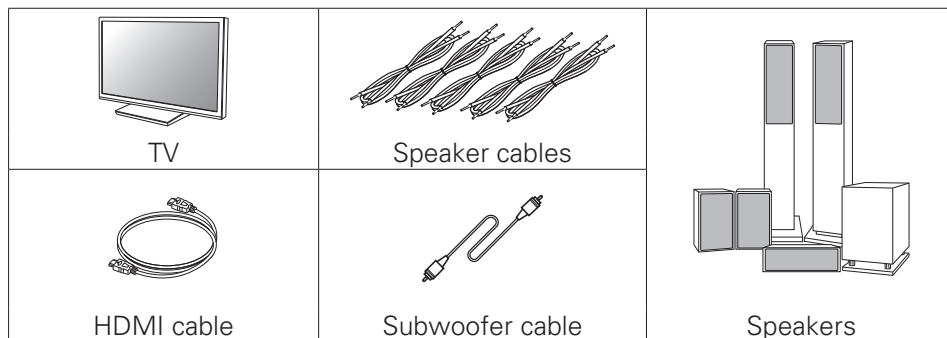



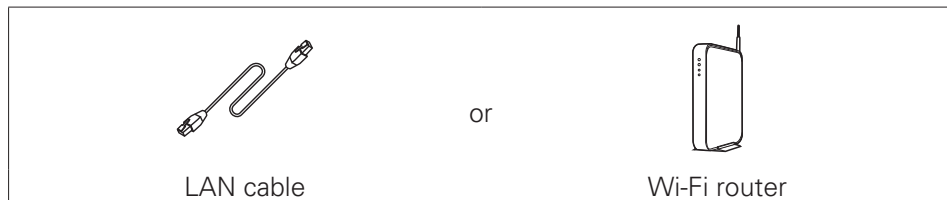











Optional



- When connecting this unit to a device that is compatible with the Deep Color, 4K and ARC functions, use a “High Speed HDMI cable with Ethernet” that displays the HDMI logo.
- These drawings are for illustrative purposes only and may not represent the actual product(s).

What's In the Box

Quick Start Guide		FM indoor antenna	
Safety Instructions		AM loop antenna	
Cautions on Using Batteries		Sound calibration microphone	
Notes on radio		Sound calibration microphone stand	
Cable labels		Remote control unit (RC036SR)	
Receiver		R03/AAA batteries	
Power cord		External antennas for Bluetooth/wireless connectivity	



- The included sound calibration microphone stand is convenient for use when performing Speaker Calibration. Using your own tripod or the supplied Sound calibration microphone stand enables settings to be automatically configured to the optimum listening environment, providing exceptionally high performance.

Important: External Antennas

The removable external antennas are required for both Bluetooth and Wireless network connectivity. Please make sure to connect the antennas before attempting to use the Bluetooth or Wi-Fi features of the SR7013.

❑ Connecting the external antennas for Bluetooth/Wireless connectivity

For each of the two antennas:

- ① Place the antenna evenly over the antenna terminal located at the upper left or right corner of the rear panel.
- ② Turn the antenna clockwise until it is fully connected. Do not over tighten.
- ③ Rotate the antenna upwards for the best possible reception.

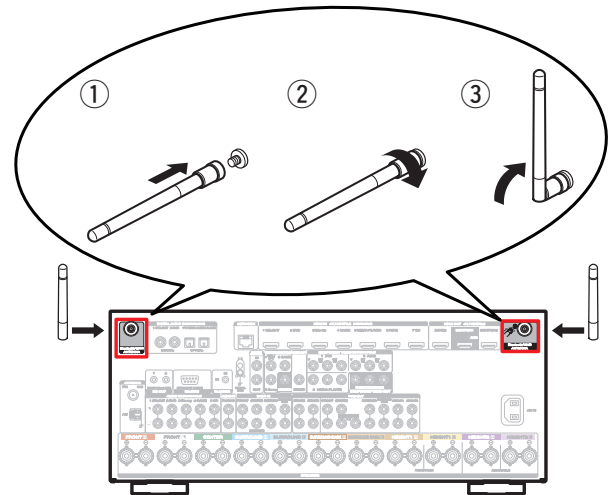

Setup

There are four steps to the setup process.

- 1** Installing batteries in the remote control unit
- 2** Connecting the receiver
- 3** Following the On-Screen Setup Assistant
- 4** Downloading the Mobile Apps

1

Installing batteries in the remote control unit

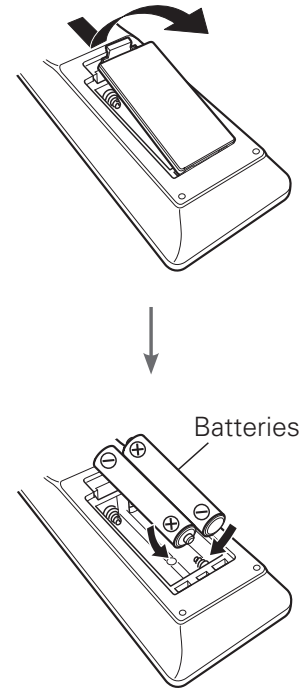

2 Connecting the receiver

- 1) Place the receiver near your TV and connect the power cord

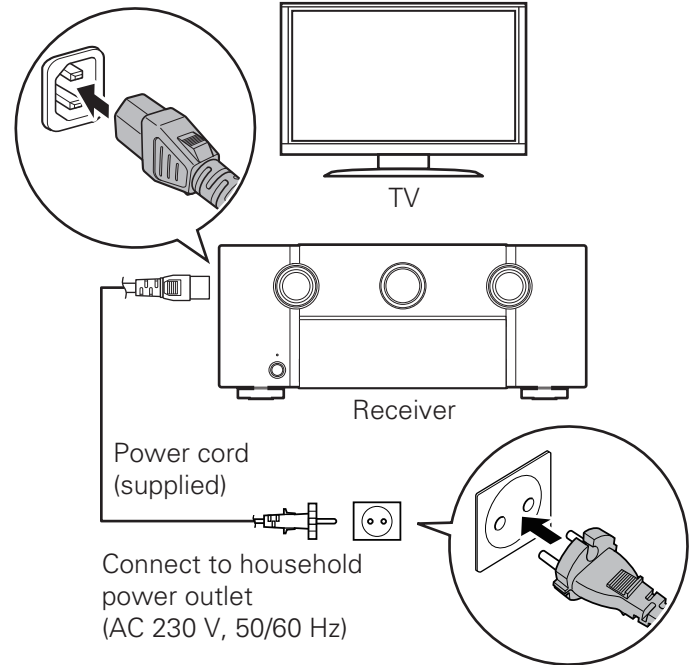

2) Connect the receiver to your home network

Wired LAN

Connect an Ethernet cable (not included) between your receiver and your network router.

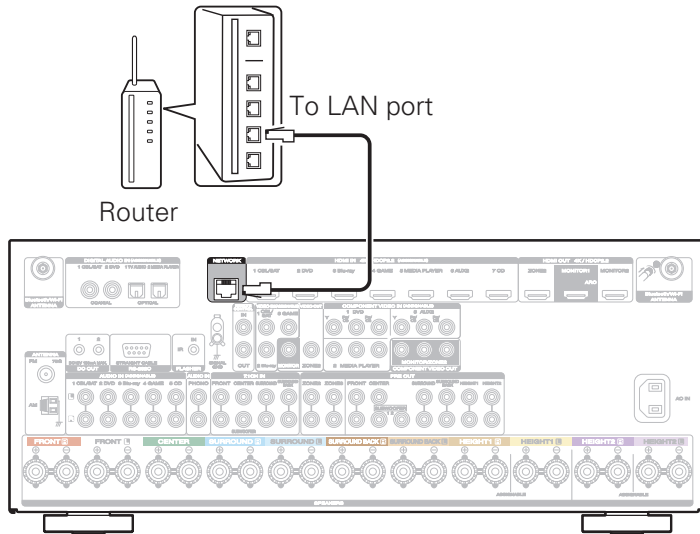

Wireless LAN

When connecting to wireless LAN (Wi-Fi), follow the instructions in “Connecting the external antennas for Bluetooth/Wireless connectivity” and connect the antennas.

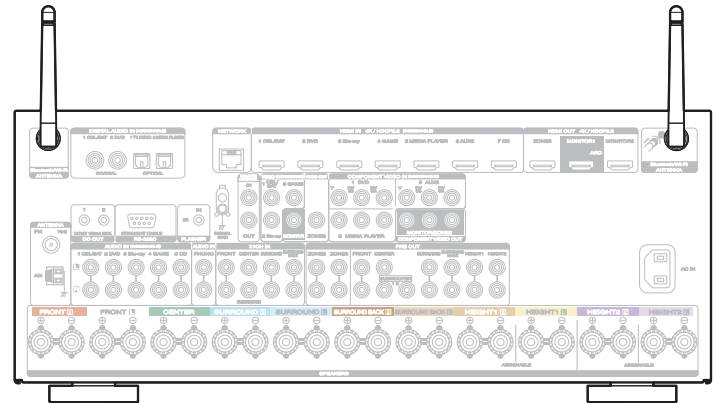

3) Connect the receiver to your TV with an HDMI cable

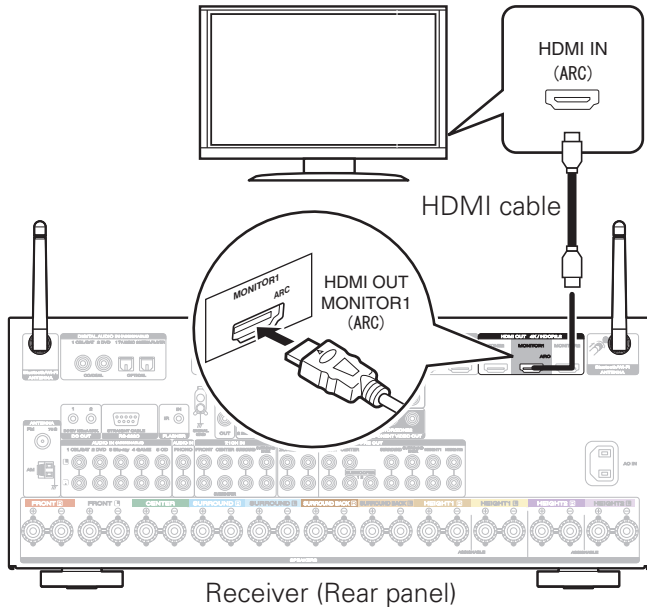

ARC (Audio Return Channel) :

If your TV supports ARC, your TV can send audio back to the AV receiver when you are using your TV's built-in video sources (TV tuner, Smart TV streaming services, etc...) ARC requires that you enable HDMI CEC on your TV. Please refer to your TV's Owner's Manual for instructions on how to setup HDMI CEC. Note that some TV manufacturers use other names for the HDMI CEC function.

4) Turn on the TV

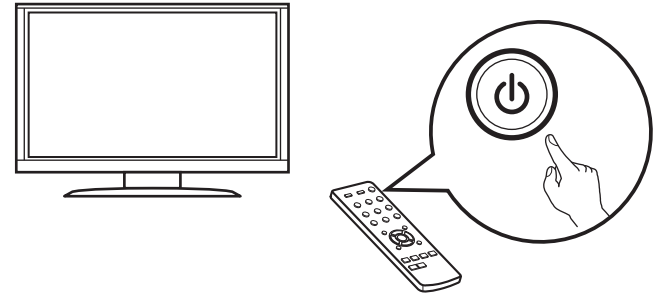

TV remote control unit

5) Select the appropriate HDMI input on your TV

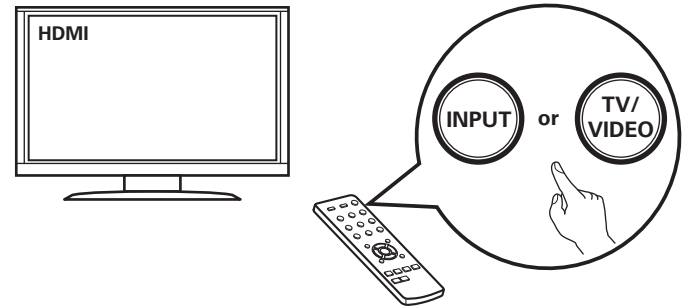

TV remote control unit

6) Turn on the receiver

- Press  to turn on the receiver.

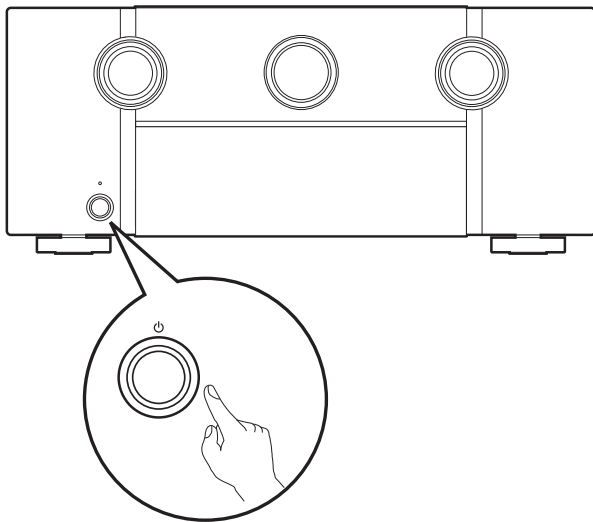

7) Verify the connection

- Verify that you can see this screen on your TV.



If this screen is not displayed, please go back and retry the steps again in the recommended sequence.

3 Following the On-Screen Setup Assistant

The Setup Assistant will walk you through connecting and configuring your speakers and components to your Marantz receiver. Please use the remote control and follow the on-screen instructions.

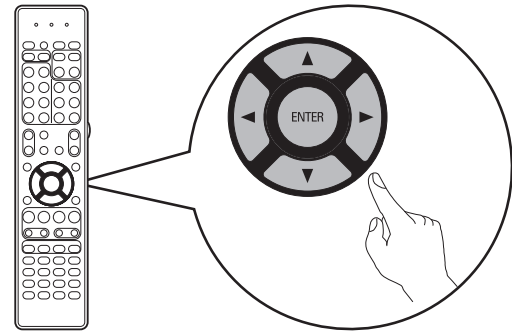

4 Downloading the Mobile Apps

Download both the “HEOS” App and the “Marantz 2016 AVR Remote” App for the full home entertainment experience. The HEOS App is required to access online music through your AVR.

HEOS



The HEOS App allows you to explore, browse, and play music from many online streaming services or from your own music library.



Marantz 2016 AVR Remote



Control your new AVR with the latest Marantz 2016 AVR Remote App. Volume control, sound mode selection and advanced settings are always only a tap away.



Owner's Manual

- For more information, visit www.marantz.com
- Refer to the Online Manual for other functions information and operation procedure details.
manuals.marantz.com/SR7013/EU/EN/



Online Manual





www.marantz.com

You can find your nearest authorized distributor or dealer on our website.

marantz[®] is a registered trademark.